

QUICK START GUIDE

Ascender 16 - 4K - Ref. ASC1602-4K



Thank you for choosing **Analog Way** and the **Ascender 16 - 4K**. By following these simple steps, you will be able to set up and use your Powerful multi-screen Seamless Switcher based on **Analog Way's** LiveCore™ platform within minutes. Discover the **Ascender 16 - 4K** capabilities and intuitive interface while commanding top-notch presentations and unleash your creativity for a new experience in show and event management.

WHAT'S IN THE BOX

- 1 x **Ascender 16 - 4K (ASC1602-4K)**
- 1 x Power supply cord
- 1 x Ethernet cross cable (for device control)
- 1 x MCO 10 pin connector
- 1 x Web-based Remote Control Software included and hosted on the device
- 1 x Rack mount kit (the parts are stowed in the packaging foam)
- 1 x User manual (PDF version)*
- 1 x Quick start guide*

* User manual and quick start guide are also available on www.analogway.com

Register
your product

Go on our website to register your product(s) and be notified about new firmware versions:
<http://bit.ly/AW-Register>

CAUTION!

The use of rear rack support slide rails for all rack mounted applications is highly recommended. Damage caused by improper rack mounting will not be covered under warranty.

QUICK SETUP & OPERATION

Connecting with the Web RCS

- Download **AW Browser** on www.analogway.com to use the Web RCS.

The **Ascender 16 - 4K** uses standard ethernet LAN networking. To connect the Web RCS to your new **Ascender 16 - 4K**, you first need to connect a computer to the **Ascender 16 - 4K** using the Ethernet cable.

Open **AW Browser** and enter the IP address of the **Ascender 16 - 4K** displaying on the front panel screen.

The connection should start.

Often, computers are set to DHCP client (automatic IP detection) mode. You may need to change the IP address configuration on your computer before you can connect. These settings are found in the properties for your LAN network adaptor, and vary by operating system.

The default IP address on the **Ascender 16 - 4K** is **192.168.2.140** with a netmask of **255.255.255.0**. Therefore, you can assign your computer a static IP address of **192.168.2.100** and a netmask of **255.255.255.0** and should be able to connect.

If the connection is not starting, please see:

- Be sure the computer IP address is on the same network and subnet as the **Ascender 16 - 4K**.
- Be sure that no two devices have the same IP address (prevent IP conflicts)
- Check your network cable. You will need a crossover ethernet cable if you are connecting directly from the **Ascender 16 - 4K** to the computer. If a hub or switch is involved, use straight ethernet cables.
- For more information, please see the user manual or contact Analog Way Technical Support.

Once you have successfully connected, the flash app will automatically download and launch in **AW Browser**. When the two icons in the bottom right corner of the screen turn green, the Web RCS is ready to use. If you are having trouble synchronizing, try clearing the cache and refreshing the page (ctrl+F5 in most browsers):

- **ASC1602-4K**: will turn green when connected
- **Sync OK**: will turn green when the Web RCS has finished synchronizing.

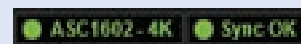

ASCENDER 16 - 4K - REF. ASC1602-4K / FRONT & REAR PANELS DESCRIPTION

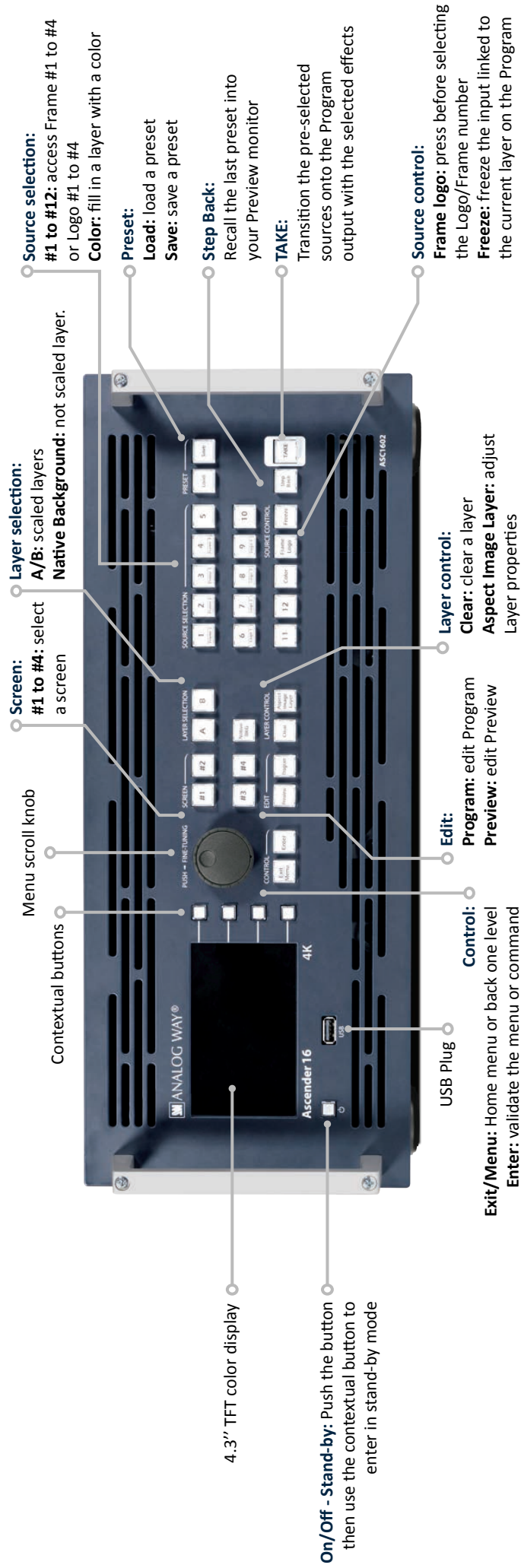

4.3" TFT color display

On/Off - Stand-by: Push the button then use the contextual button to enter in stand-by mode

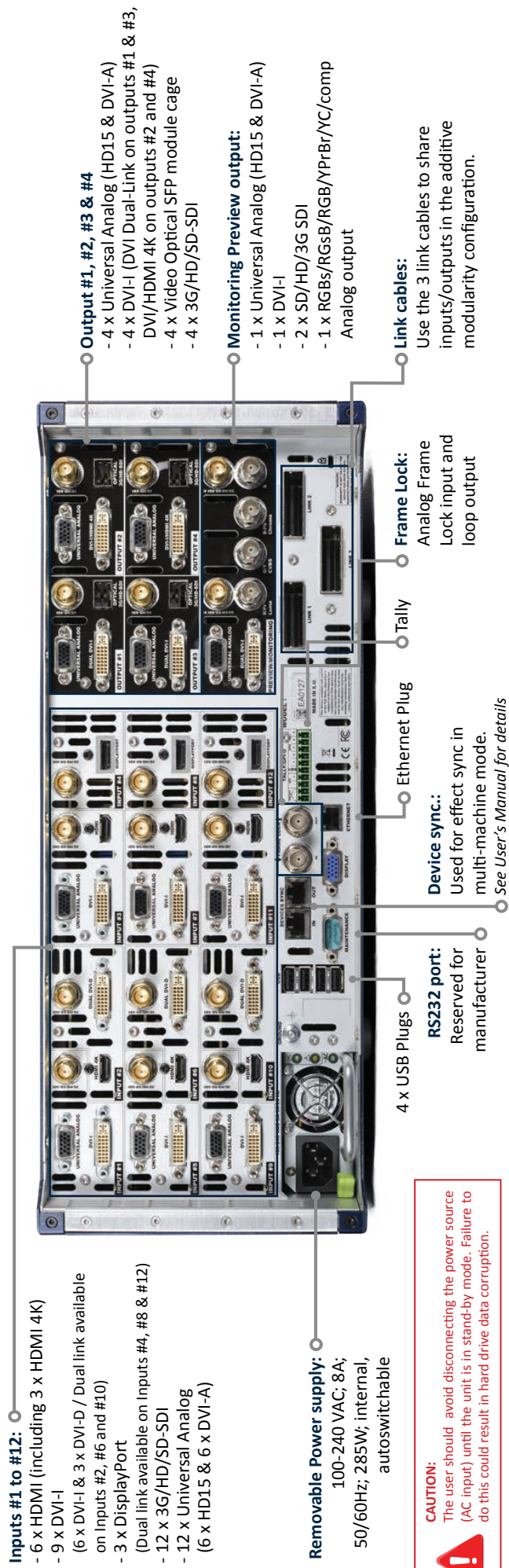

Inputs #1 to #12:





- 6 x HDMI (including 3 x HDMI 4K)
- 9 x DVI-I (6 x DVI-I & 3 x DVI-D / Dual link available on Inputs #2, #6 and #10)
- 3 x DisplayPort (Dual link available on Inputs #4, #8 & #12)
- 12 x 3G/HD/SD-SDI
- 12 x Universal Analog (6 x HD15 & 6 x DVI-A)

Removable Power supply:
100-240 VAC; 8A;
50/60Hz; 285W; internal,
autoswitchable

CAUTION:
The user should avoid disconnecting the power source (AC input) until the unit is in stand-by mode. Failure to do this could result in hard drive data corruption.

OPERATION OVERVIEW

BUTTON COLOR USAGE

- Solid red:**  #1 = Source is on the Program output
#2 = Freeze enable
#3 = Stand-by button
#4 = Preset Selection
- Solid green:**  #1 = Source is on Preview
#2 = Function available for modification
- Blinking red:**  Layer/source selected and is currently active on the Program output
- Blinking green:**  Layer/source selected and is not currently active on the Program output
- Solid orange:**  Contextual button

OUTPUT SETUP

- Operation mode:**
Choose your operation mode using the setup menu (**SETUP > Preconfig > screens**) to drag and drop your unused output to the selected mode.
- Output format/rate:**
Under **SETUP > OUTPUT**, click on the selected output on the left to have access to the setup. Then choose the format and rate. (Rate choice is only available for preview output, the main output will use the rate defined under **SETUP > Preconfig > Internal rate, Framelock, etc.**)
- Output settings:**
Under this menu you have access to the **HDCP ON/OFF** feature, Optical SFP restart and test pattern possibilities.
- TIP:** Always try to use native resolution of your screens/projectors to avoid additional scaling.

INPUT SETUP

- Click on **SETUP > INPUT > GENERAL** to have an overview of your inputs.
- Click on **AUTOSET ALL** to launch the automatic detection of all inputs once all sources are connected and turned on.
- Individual input setting:**
Click on the left on the individual input setup in order to define your input
- As each input has multiple input plugs, you must choose one plug to display as this input. The remaining non-displayed plugs remain active and can still be configured.
- Click on your **ACTIVE PLUG** in order to choose the displayed input.
- Click on the **SETUP PLUG** to start setup of a plug not currently chosen as the active plug. (Not necessarily displayed).



EDIT

- Once your setup is complete, click on the **EDIT** tab to start building your presets.
- Resize or reposition your layer by clicking and dragging the layer.
 - Load and place all your layers with your mouse and use the take button to send it to your program
 - Drag sources into layers to change the source
- Other settings are available for layers, please refer to the user manual.

SETUP MENU

- Preconfig:** Setup assistant for adjusting all basic setups.
- Outputs:** Manage your outputs and have access to every settings and parameters.
- Inputs:** Configure your inputs connected to your **Ascender 16 - 4K**.
- Library:** Load your Logos and Frames into the system.
- Logos:** Configure Logos and Frames selections.
- Confidence:** Configure the Confidence monitor.
- Monitoring:** Configure the operator's monitor including the resolution and choice of layout, to show input or output preview combinations.
- Blending:** Configure the blending.
- Services:** Access to all Analog Way maintenance services (update, etc.).
- Control:** Access all control settings.

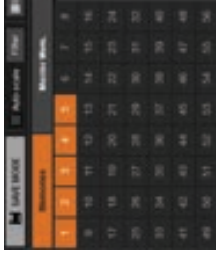
PRESET MANAGEMENT

- Once you build a preset, you can save it as one of the 144 preset slots the **Ascender 16 - 4K** offers.
- Click on **SAVE MODE** then choose your preset number.
- 
- 
- You can load your preset at any time on Program or Preview by clicking on the preset number (with the **Save mode** button disabled), or simply drag and drop the preset into the Program or Preview windows.
 - To reset a preset, please click on the preset number holding **SHIFT** on your keyboard. Then into the windows below click on the reset button 

WEB RCS STRUCTURE



SETUP

Click on **SETUP**, then go to the preconfig button. The Setup assistant is here to help you to set up step by step your unit by following an interactive tutorial.



EDIT

The **EDIT** mode is the place where you will manage all your configurations. You will manage your inputs, your layers in terms of size position effect etc... your Frames and Logos. You can save all your screen configurations into presets



LIVE

The **LIVE** mode is the section where you will start operating your show. You can play presets one after the other on a real timeline adding some parameters like duration or wait for user interaction.

WARRANTY AND SERVICE

This **Analog Way** product has a 3 year warranty on parts and labor, back to factory. This warranty does not include faults resulting from user negligence, special modifications, electrical surges, abuse (drop/crush), and/or other unusual damage. In the unlikely event of a malfunction, please contact your local **Analog Way** office for service.

GOING FURTHER WITH THE ASCENDER 16 - 4K

For complete details and operational procedures, please refer to the **LiveCore's** unit User's Manual and our website for further information: www.analogway.com